



RŪPESTINGŲ
PRIEMONIŲ
KATALOGAS



SLAUGOS IR NEIĞALIŲJŲ
TECHNIKA

AIDS FOR HANDICAPPED

PALĪDZĪBA INVALĪDIEM



Asmeninė paskyra
Personal account
Lietotāja konts



24/7 savitarna
24/7 self service
24/7 pašapkalpošanas
serviss



Produktai sandēlyje
Products in stock
Produkts ir noliktavā

“Kid-Man” is legitimate trademark of UAB Kasko Group. All rights reserved.

©2018 UAB Kasko Group.

TURINYS

CONTENT / SATURS

Judėjimui Mobility Kustībām

Tualetui Toilet Tualetei

Voniai Bathroom Vannai

Slaugai Care Aprūpei

VILNIUS, LIETUVA
2018



Simboliai Symbols Simboli



Maksimali apkrova
Maximum load
Maksimāla slodze



Svoris
Weight
Svars

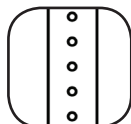

Aukščio reguliavimo padėtys
Height adjustment positions
Augstuma regulėšanas pozīcijas

2in1

Du viename
Two in one
Divi vienā



Komplektuojama su įrankiais
Tools set included
Komplektēti ar darbarīkiem



Komplektuojama su pompa
Pump included
Iekļauts pumpis

Al
Aluminium

Aliuminio konstrukcija
Aluminium frame
Alumīnija rāmis



Lengvas
Lightweight
Viegls



Komplektuojama su būgniniais stabdžiais
Drum brakes included
Trumuļu bremzes iekļautas



Porolono tankis
Density of foam
Putu blīvums



Pagaminta iš viskoelastinio porolono
Made of viscoelastic foam
Izgatavots no viskoelastīgām putām

I

Pragulų rizikos lygis
Bedsore risk level
Izgulējumu riska līmenis



Komplektuojama su užvalkalu

Cover included

Pārvalks iekļauts



Sudētis: 50% HR porolono ir 50% poliesterio pluoštas

Composition: 50% HR foam and 50% polyester

Pildītājs: 50% HR porolona un 50% poliestera šķiedras



Sudētis: 100% HR porolono

Composition: 100% HR foam

Pildītājs: 100% HR porolona



Skysčiems nelaidus

Waterproof

Ūdensnecaurļaidīgs



Orui pralaidus

Breathable

Gaisa caurlaidīga



Anti-bakterinis audinys

Anti-bacterial

Anti-baktēriju



Medicininis audinys

Special medical fabric

Medicīniskā auduma



Skalbiamas 95°

Washable at 95°

Mazgājams līdz 95°



Skalbiamas apie 200 kartų

Washable about 200 times

Mazgājams ap 200 reizēm



Viskoelastinis porolonas atitinka „Oeko Tex” standarto 1-os klasės reikalavimus.

Viscoelastic foam meets 1st class requirements of “Oeko Tex” Standard.

Viskoelastīgas putas atbilst pirmās klases “Oeko Tex” standarta prasībām.



Pagalvės atitinka „Ultra-Fresh” antimikrobinus reikalavimus

Pillows meet all “Ultra-Fresh” antimicrobial requirements.

Spilveni atbilst visām antibakteriālām “Ultra-Fresh” prasībām.



Judējimui Mobility Kustībām

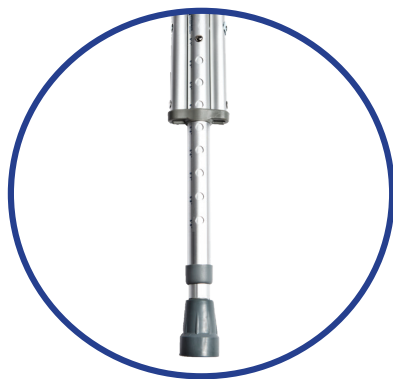

PAŽASTINIS ALIUMINIS RAMENTAS
ALUMINIUM UNDERARM CRUTCH
ALUMĪNIJA PADUSES KRUŽIS

01-2003NE 01-2002NE 01-2001NE



 Max. kg 120 kg	 Kg 0,8 kg	 A	01-2003NE A: 93-113 cm
			01-2002NE A: 114-134 cm
			01-2001NE A: 135-155 cm

Judėjimui
ALKŪNINIS RAMENTAS
 ELBOW CRUTCH
 ELKOŅA KRUŽIS

 220DK/S 220DK/M 220DK/L
 220DSK/M 220DSK/L

 220DSK
 Paminkštinta rankena
 Soft handle
 Mīksts rokturis

140 kg



0,55 kg



220DK/S	A: 50-70 cm
220DK/M	A: 76-96 cm
220DK/L	A: 90-110 cm
220DSK/M	A: 76-96 cm
220DSK/L	A: 90-110 cm

ALUMINĖ LAZDELĖ ALUMINIUM WALKING STICK ALUMĪNIJA SPIEKĪS

01-2324 01-2331



Medinė rankena
Wooden handle
Koka rokturis

Plastmasinė rankena
Plastic handle
Plastmasas rokturis

 100 kg	 0,35 kg	 73-95 cm	 10
------------	-------------	--------------	--------

Judėjimui

ALIUMINĖ LAZDELĖ SUNKIASVORIUI
ALUMINIUM WALKING STICK FOR A HEAVYWEIGHT PERSON
ALUMĪNIJA SPIEĶIS SMAGSVARAM

01-2300HD



225 kg



0,5 kg

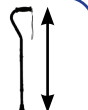

73-96 cm

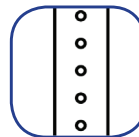

10

MEDINĖ LAZDELĖ
WOODEN CANE
KOKA SPIEĖIS

02-2501

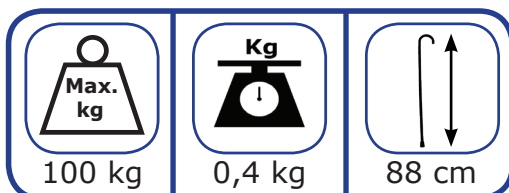



Judėjimui

SUEDAMA LAZDELĖ
FOLDING ALUMINIUM WALKING STICK
ALUMĪNIJA SPIEKĪS, SALIEKAMS

01-2352



12

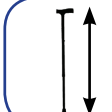
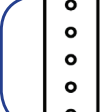

 100 kg	 0,35 kg	 79-89 cm	 5
---	--	---	--

Judėjimui

ALIUMINĖ LAZDELĖ SU LED PROŽEKTORIUMI ALUMINIUM WALKING STICK WITH LED SPOTLIGHT ALUMĪNIJA SPIEKĪS, AR LED LAMPU

05-YFLED

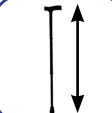
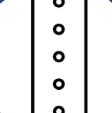

 100 kg	 0,35 kg	 73-95 cm	 10
---	--	---	---

Judėjimui

TRIKOJĖ IR KETURKOJĖ LAZDELĖ
TRIPOD AND QUAD CANE
TRIPODS UN KVADRIPODS

01-2620 01-7782C

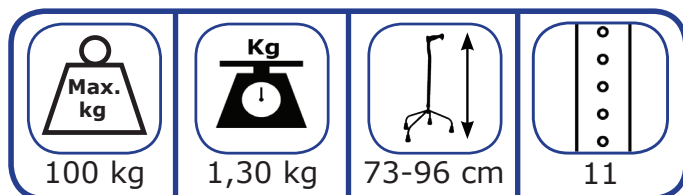

ŽIEMINIS ANTĖGALIS

ICE GRIP

ZIEMAS UZĖGALIS

01-2900 01-2901



 0,1 kg	01-2900	5 spygliai 5 spikes 5 radzes
	01-2901	1 spyglys 1 spike 1 radze

Judėjimui

VASARINIS GUMINIS ANTĖGALIS UTILITY TIP **VASARAS GUMIJAS UZĖGALIS**

01-2906 01-2013 01-2010 01-3730



Kodas / Code / Kods	Skersmuo / Diameter / Diametrs
01-2906	16 mm
01-2013	18 mm
01-2010	22 mm
01-3730	24 mm

PAMINKŠTINIMAI PAŽASTINIAMS RAMENTAMS
CUSHIONS FOR UNDERARM CRUTCHES
POLSTERĒJUMI PADUSES KRUŽIEM

01-2014 01-2015



01-2014



01-2015

Kodas / Code / Kods	Paskirtis / Purpose / Paredzēts
01-2014	Pažasčiai / For armpit / Paduses atbalstam
01-2015	Delnui / For hand / Rokturim

Judėjimui

VAIKŠČIOJIMO RĖMAS
WALKING FRAME
STAIGĀŠANAS RĀMIS

01-3203



AI
Aluminium



18

 130 kg	 2,7 kg	 81-99 cm	 47 cm
------------	------------	--------------	-----------

ŽINGSNIUOJANTIS VAIKŠČIOJIMO RĖMAS RECIPROCATING WALKING FRAME STAIGĀŠANAS RĀMIS SOĻOŠANAI

01-3213



2in1

- *Lengva pakeisti į įprastą vaikščiojimo rėmą.
- *Easy to switch from reciprocating to static.
- *Vieglai pārveidot par parastu staigāšanas rāmi.

<p>100 kg</p>	<p>2,5 kg</p>	<p>81-99 cm</p>	<p>47 cm</p>
---------------	---------------	-----------------	--------------

Judėjimui

VAIKŠČIOJIMO RĖMAS 2 SEKCIJŲ
WALKING FRAME, TWO SECTIONS
STAIGĀŠANAS RĀMIS AR 2 SEKCIJĀM

01-3900



120 kg



2,7 kg



80-99 cm



53 cm

Judėjimui

VAIKŠČIOJIMO RĖMAS SU RATUKAIS
WALKING FRAME WITH WHEELS
STAIGĄŠANAS RĖMIS AR RITENIEM SALIEKAMASIS

01-3016W5



 120 kg	 2,9 kg	 81-99 cm	 50 cm
------------	------------	--------------	-----------





Judėjimui

VAIKŠTYNĖ SU 2 RATUKAIS IR 2 PĖDELĖM SU SĖDYNE HANDCART WITH SEAT STAIGULIS AR 2 RITENIEM UN SĖDEKLI

01-3511



22





 <p>Max. kg</p>	 <p>Kg</p>		
100 kg	5,6 kg	76-100 cm	38 cm

Judėjimui

LAUKO VAIKŠTYNĖ SU 3 RATUKAIS
3 WHEEL ROLLATOR
ĀRA STAIGULIS AR 3 RITENIEM

02-5041B



 120 kg	 7,2 kg	 82-97 cm	 57 cm
---	---	---	--





Judėjimui

LAUKO VAIKŠTYNĖ SU 3 RATUKAIS IR KREPŠIU
3 WHEEL ROLLATOR WITH BAG
ĀRA STAIGULIS AR 3 RITENIEM UN GROZU

02-5041C



24





 <p>Max. kg</p>	 <p>Kg</p>		
120 kg	8,0 kg	82-97 cm	57 cm

Judėjimui

LAUKO VAIKŠTYNĖ SU 4 RATUKAIS
4 WHEEL ROLLATOR
ĀRA STAIGULIS AR 4 RITENIEM

04-4200F



 130 kg	 9,8 kg	 71-98 cm	 60 cm
---	---	---	--

Judėjimui

LAUKO VAIKŠTYNĖ SU 4 RATUKAIS
4 WHEEL ROLLATOR
ĀRA STAIGULIS AR 4 RITENIEM ATV.

EGO

01-3500



26





 135 kg	 7,2 kg	 85-102 cm	 61 cm
------------	------------	---------------	-----------

LAUKO VAIKŠTYNĖ SU 4 RATUKAIS
4 WHEEL ROLLATOR
ĀRA STAIGULIS AR 4 RITENIEM ATV.

FARGO

01-3520



 135 kg	 8,7 kg	 80,5-93 cm	 65 cm
---	---	---	--

Judējimui

KAMBARINĒ VAIKŠTYNĒ
INDOOR ROLLATOR
ROLATORS IEKŠTELPĀM

INGO

01-3510

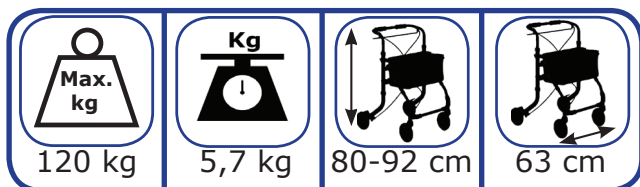





Judėjimui

VAIKŠTYNĖ SU STALIUKU
WALKER WITH TABLE
STAIGULIS AR GALDINŲ

MUVI

MUVI100



 130 kg	 11,5 kg	 79-125 cm	 62 cm
---	--	--	--

Judėjimui

RANKŲ-KOJŲ TRENIRUOKLIS
PEDALLER
VELORITENIS

01-5720



100 kg

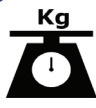

2,2 kg



26 cm



41,5 cm



UNIVERSALIAUS TIPO NEĮGALIOJO VEŽIMĖLIS STANDART WHEELCHAIR UNIVERSALIE INVALĪDU RATIŅI

STEELMAN START

04-020-2 04-020-3



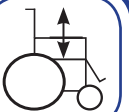

- * Yra galimybė įsigyti vežimėlį su nepripučiamais ratais - 04-020-3
- * Available to buy a wheelchair with non-inflatable wheels - 04-020-3
- * Ir iespēja nopirkt ratiņkrēsli ar monolītām riepiņām - 04-020-3

 Max. kg 120 kg	 90,5 cm	 105 cm	 40,5 cm
---	--	---	--

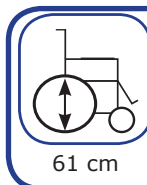
Judėjimui

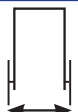
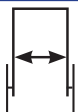

Kodas Code Kods				
04-020-2/36 04-020-3/36	54 cm	36 cm	26 cm	17,4 kg
04-020-2/38 04-020-3/38	56 cm	38 cm	26 cm	17,5 kg
04-020-2/41 04-020-3/41	59 cm	41 cm	26 cm	17,6 kg
04-020-2/43 04-020-3/43	61 cm	43 cm	26 cm	17,7 kg
04-020-2/46 04-020-3/46	64 cm	46 cm	26 cm	17,9 kg
04-020-2/48 04-020-3/48	66 cm	48 cm	26 cm	18 kg

PERVEŽIMO VEŽIMĖLIS
TRANSIT WHEELCHAIR
TRANSPORTA KRESLS

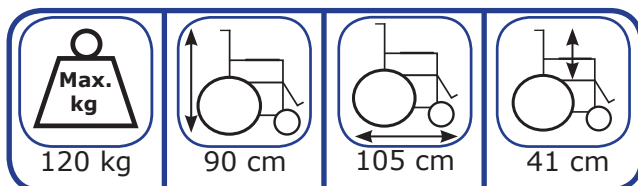

STEELMAN TRAVEL

04-008B-3

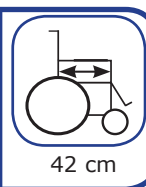
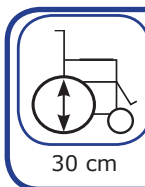

Judėjimui

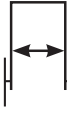

Kodas Code Kods				
04-008B-3/38	56 cm	38 cm	26 cm	15,0 kg
04-008B-3/41	59 cm	41 cm	26 cm	15,2 kg
04-008B-3/43	61 cm	43 cm	26 cm	15,4 kg
04-008B-3/46	64 cm	46 cm	26 cm	15,6 kg
04-008B-3/48	66 cm	48 cm	26 cm	15,8 kg

LENGVO LYDINIO NEIĞALIOJO VEŽIMĖLIS
LIGHTWEIGHT WHEELCHAIR
VIEGLAIS INVALĪDU KRĒSLS

LIGHTMAN START

04-030-2 04-030-3





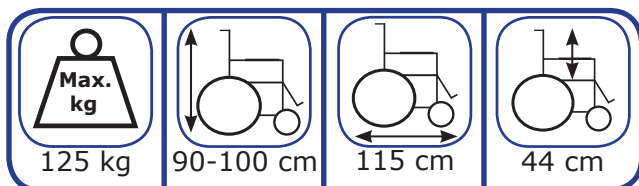

- * Yra galimybė įsigyti vežimėlį su nepripučiamais ratais - 04-030-3
- * Available to buy a wheelchair with non-inflatable wheels - 04-030-3
- * Ir iespēja nopirkt ratīkkrēslu ar monolītām riepām - 04-030-3

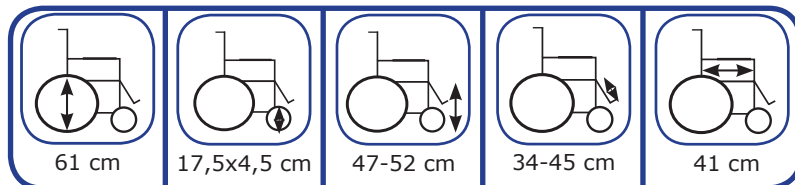

Judėjimui



Kodas Code Kods					
04-030-2/39 04-030-3/39	59 cm	39 cm	31 cm	15,2 kg	
04-030-2/42 04-030-3/42	62 cm	42 cm	31 cm	15,4 kg	
04-030-2/45 04-030-3/45	65 cm	45 cm	31 cm	15,6 kg	
04-030-2/48 04-030-3/48	68 cm	48 cm	31 cm	15,8 kg	
04-030-2/51 04-030-3/51	71 cm	51 cm	31 cm	16,0 kg	

Judėjimui

LENGVO LYDINIO NEIĞALIOJO VEŽIMĖLIS
LIGHTWEIGHT WHEELCHAIR
VIEGLAIS INVALĪDU KRĒSLS

LIGHTMAN START PLUS

04-035-2

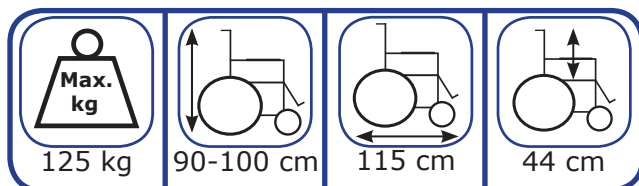

Judėjimui

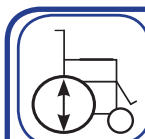

61 cm

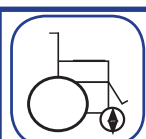

17,5x4,5 cm



47-52 cm



34-45 cm

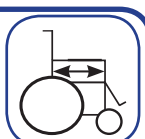

41 cm

Kodas Code Kods					Kg
04-035-2/39	59 cm	39 cm	34 cm	15,7 kg	
04-035-2/42	62 cm	42 cm	34 cm	15,9 kg	
04-035-2/45	65 cm	45 cm	34 cm	16,1 kg	
04-035-2/48	68 cm	48 cm	34 cm	16,3 kg	
04-035-2/51	71 cm	51 cm	34 cm	16,5 kg	

LENGVO LYDINIO NEIĞALIOJO VEŽIMĖLIS
LIGHTWEIGHT WHEELCHAIR
VIEGLAIS INVALĪDU KRĒSLS

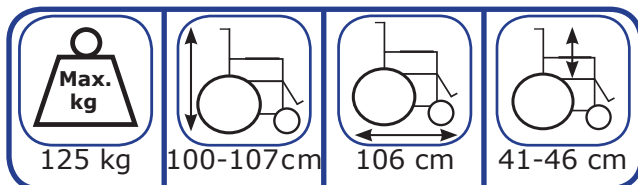

LIGHTMAN COMFORT

04-040-2

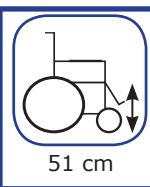
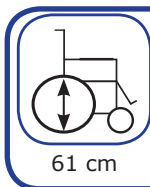

Judėjimui

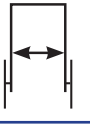

Kodas Code Kods				
04-040-2/41	63 cm	41 cm	40 cm	17,4 kg
04-040-2/43	65 cm	43 cm	40 cm	17,7 kg
04-040-2/46	68 cm	46 cm	40 cm	17,8 kg
04-040-2/48	70 cm	48 cm	40 cm	18,0 kg
04-040-2/51	73 cm	51 cm	40 cm	18,1 kg

LENGVO LYDINIO NEIĞALIOJO VEŽIMĖLIS
LIGHTWEIGHT WHEELCHAIR
VIEGLAIS INVALĪDU KRĒSLS

LIGHTMAN COMFORT PLUS

04-045-2

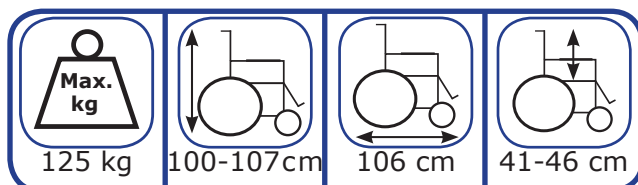

Judėjimui

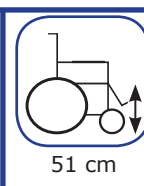
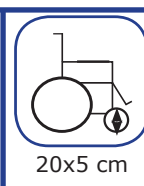
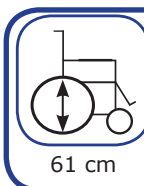





Kodas Code Kods				
04-045-2/41	63 cm	41 cm	40 cm	18,0 kg
04-045-2/43	65 cm	43 cm	40 cm	18,2 kg
04-045-2/46	68 cm	46 cm	40 cm	18,4 kg
04-045-2/48	70 cm	48 cm	40 cm	18,6 kg
04-045-2/51	73 cm	51 cm	40 cm	18,8 kg

Judėjimui

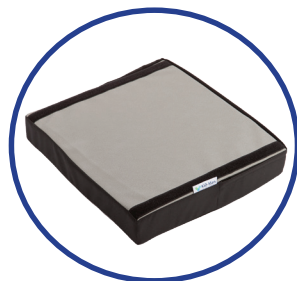
POROLONO PAGALVĖLĖ VEŽIMĖLIUI WHEELCHAIR CUSHION FOAM POROLONA SPILVENTIŪŠ RATIŅIEM

C-01

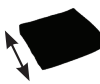

Kodas Code Kods			
C-01/38x41	38 cm	41 cm	5 cm
C-01/41x41	41 cm	41 cm	5 cm
C-01/43x41	43 cm	41 cm	5 cm
C-01/46x41	46 cm	41 cm	5 cm
C-01/48x41	48 cm	41 cm	5 cm
C-01/51x41	51 cm	41 cm	5 cm

Judėjimui

ANATOMINĖ PAGALVĖLĖ VEŽIMĖLIUI



ANATOMIC WHEELCHAIR CUSHION

ANATOMISKS SPILVENS INVALĪDU RATIŅKRĒSLAM

VISKOFORM

ViskoForm



Kodas Code Kods			
ViskoForm/42x42x8	42 cm	42 cm	8 cm
ViskoForm/46x42x8	46 cm	42 cm	8 cm
ViskoForm/48x43x8	48 cm	43 cm	8 cm
ViskoForm/50x43x8	50 cm	43 cm	8 cm



Tualetui Toilet Tuaeleti



SUGLAUDŽIAMA TUALETO KĖDĖ
FOLDABLE COMMODE
SALIEKAMS TUALETES KRĖSLS

KOMO

01-5205HD

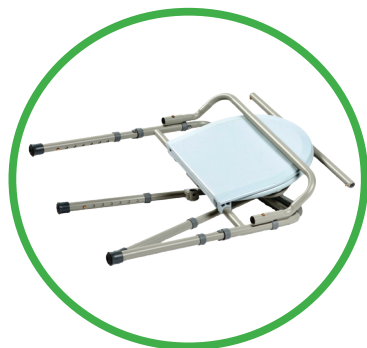

135 kg



5,2 kg



42-57 cm



48 cm

Tualetui

TUALETO KĖDĖ SUNKIASVORIUI
HEAVY DUTY COMMODE
TUALETES KRĖSLS SMAGAM CILVĖKAM

KOMO HD

01-5205HD



48



250 kg



8,1 kg



45-55 cm



52 cm



58 cm

Tualetui

TUALETO KĖDĖ BE RATUKŲ COMMODE WITHOUT WHEELS TUALETES KRĖSLS BEZ RITENIEM

02-7020



100 kg



7,9 kg



85 cm



44 cm



47 cm

Tualetui

TUALETO KĖDĖ SU PAMINKŠTINTA SĖDYNE COMMODE WITH SOFT SEAT TUALETES KRĖSLS AR POLSTERĖTU SĖDEKLI

04-7400



50



130 kg



7,8 kg



46-51 cm



43 cm



46-51 cm

Tualetui

SULANKSTOMA TUALETO KĖDĖ
FOLDABLE COMMODE
SALIEKAMS TUALETES KRĖSLS

04-7410

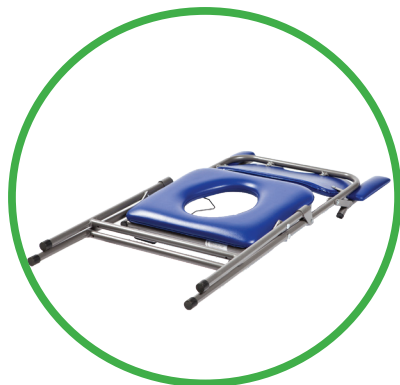

120 kg



10,6 kg



92 cm



43 cm



53 cm

Tualetui

TUALETO KĖDĖ
COMMODE CHAIR
TUALETES KRĖSLS

04-7420



52



130 kg



9,5kg



90-105 cm



48 cm



50-65 cm

Tualetui

TUALETO - DUŠO KĖDĖ
COMMODE - SHOWER CHAIR
TUALETES UN DUŠAS KRĒSLS

AKVA

01-5209A



120 kg



9,8 kg



70 cm



46 cm



48 cm

Tualetui

TUALETO - DUŠO VEŽIMĒLIS
COMMODE - SHOWER WHEELCHAIR
TUALETES UN DUŠAS RATIŅI

AKVA GO

01-5209B



Al
Aluminium

54



120 kg



14,2 kg



95 cm



46 cm



48 cm

Tualetui

TUALETO KĖDĖ
COMMODE
TUALETES KRĖSLS AR RITENIEM

02-8015C



130 kg



12,4 kg



95 cm



45 cm



49 cm

Tualetui

PAAUKŠTINIMAS TUALETO SĖDYNEI SU DANGČIU RAISED TOILET SEAT WITH LID **PAAUGSTINĀJUMS TUALETES SĒDEKLIM VAKU**

02-7060L4 02-7060L6



Kodas
Code
Kods

02-7060L4
02-7060L6



225 kg
225 kg





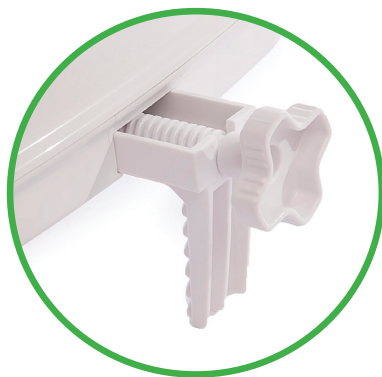

Tualetui

PAAUKŠTINIMAS TUALETO SĖDYNEI **RAISED TOILET SEAT** **PAAUGSTINĀJUMS TUALETES SĒDEKLIM**

02-7060S4



 225 kg	 1,3 kg	 10 cm	 36 cm
---	---	--	--

Tualetui

LAIKIKLIS PRIE SIENOS
FOLDING WALL SUPPORT RAIL
TURĖTĀJS PIE SIENAS

06-7140

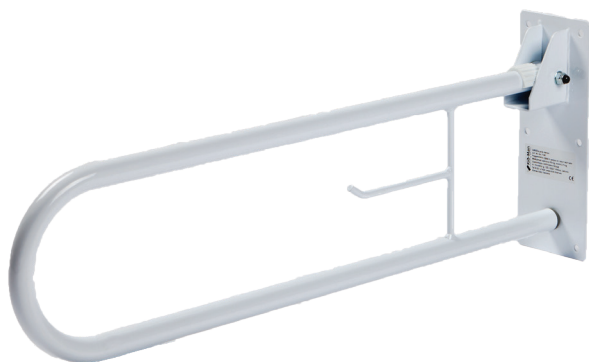

90 kg



2,3 kg

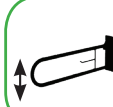

20 cm

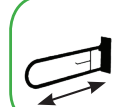





75 cm

Tualetui

Į GRINDIS TVIRTINAMAS LAIKIKLIS
FLOOR MOUNTED RAIL
PIE GRĪDAS MONTĒJAMS ATBALSTA ROKTURIS

06-7142



 115 kg	 8 kg	 32 cm	 76,5 cm
---	---	--	--

Tualetui

LAIKIKLIS PRIE TUALETO, DVIPUSIS TOILET SUPPORT TURĖTĀJS PIE TUALETES, DIVPUSĒJS

01-5300KD



60



100 kg



1,5 kg



63-73 cm



50-60 cm

Voniai Bathroom Vannai



Voniai

DUŠO KĖDĖ
SHOWER CHAIR
DUŠAS KRĖSLS

01-5040



62



100 kg



1,5 kg



33-50,5 cm



33 cm

Voniai

DUŠO KĖDĖ BE ATRAMOS NUGARAI
SHOWER CHAIR WITHOUT BACK
DUŠAS KRĖSLIS BEZ MUGURAS BALSTA

01-5005



135 kg

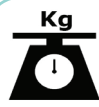

2,0 kg



33-50 cm



51 cm



45 cm

Voniai

SULANKSTOMA DUŠO KĖDĖ
FOLDABLE SHOWER CHAIR
SALOKĀMS DUŠAS KRĒSLS

02-6025A



64



100 kg



3,1 kg



48 cm



49 cm

Voniai

DUŠO KĖDĖ PLAČIA NUGARA
SHOWER CHAIR WITH WIDE BACK
DUŠAS KRĖSLAS AR PLATU MUGURU

01-5000KD



135 kg



2,7 kg



71-81 cm



49 cm



34,5-44,5 cm

65

Voniai

DUŠO KĖDĖ SU IŠPJOVA
"U" SHAPED SHOWER CHAIR
DUŠAS KRĖSLAS AR IZGRIEZUMU

01-5015KD



66



100 kg



2,7 kg



71-81cm



49 cm



34,5-44,5 cm

Voniai

DUŠO KĖDĖ
SHOWER CHAIR
DUŠAS KRĖSLIS AR NOŃEMAMIEM ROKU BALSTIEM

02-6055



100 kg



3,2 kg



71 cm



53 cm



41,5-55 cm

Voniai

VONIOS SUOLIUKAS
SHOWER BENCH
VANNAS SOLIŅŠ

02-6030A



68



100 kg



4,7 kg



43-53 cm



77 cm

Voniai

VONIOS LENTA
SHOWER BOARD
VANNAS SOLIŅŠ

02-6045C



150 kg



2,4 kg



31 cm



69 cm

Voniai

VONIOS SUOLIUKAS
BATH BENCH
VANNAS SĖDEKLIS

Fiji316



70



130 kg



3,5 kg



41 cm



70-85 cm

Voniai

DUŠO SUOLIUKAS
WALL MOUNTED SHOWER BENCH
DUŠAS SOLIŅŠ

01-5105



180 kg



4,6 kg

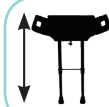

38-53cm



41,5 cm

Voniai

VONIOS LAIKIKLIS
BATHROOM SAFETY
VANNAS TURĒTĀJS

01-5420ADJ



72



100 kg



3,1 kg







37,5-46,5 cm

Voniai

PLASTIKINIS LAIKIKLIS PRIE SIENOS
PLASTIC GRABBAR
PLASTMASAS SIENAS TURĒTĀJS

02-6098 02-6097 02-6096 02-6095





Kodas Code Kods		 Max. kg	 Kg	
02-6098	61 cm	130 kg	0,6 kg	7,8 cm
02-6097	45 cm	130 kg	0,5 kg	7,8 cm
02-6096	40 cm	130 kg	0,4 kg	7,8 cm
02-6095	30 cm	130 kg	0,3 kg	7,8 cm

Voniai

METALINIS LAIKIKKLIS PRIE SIENOS (CHROMUOTAS)
STEEL GRABBAR (CHROMED)
METĀLA SIENAS TURĒTĀJS (HROMĒTS)

01-54032C 01-54024C 01-54018C 01-54016C 01-54012C







Kodas Code Kods		 Max. kg	 Kg	
01-54032C	81 cm	130 kg	0,8 kg	6,5 cm
01-54024C	61 cm	130 kg	0,7 kg	6,5 cm
01-54018C	45 cm	130 kg	0,6 kg	6,5 cm
01-54016C	40 cm	130 kg	0,5 kg	6,5 cm
01-54012C	30 cm	130 kg	0,4 kg	6,5 cm

Voniai

METALINIS LAIKIKLIS PRIE SIENOS (DAŽYTAS)
STEEL GRABBAR (PAINTED)
METĀLA SIENAS TURĒTĀJS (KRĀSOTS)

01-54032P 01-54024P 01-54018P 01-54016P 01-54012P



Kodas Code Kods		 Max. kg	 Kg	
01-54032P	81 cm	130 kg	0,8 kg	6,5 cm
01-54024P	61 cm	130 kg	0,7 kg	6,5 cm
01-54018P	45 cm	130 kg	0,6 kg	6,5 cm
01-54016P	40 cm	130 kg	0,5 kg	6,5 cm
01-54012P	30 cm	130 kg	0,4 kg	6,5 cm

Slaugai Care Aprūpei

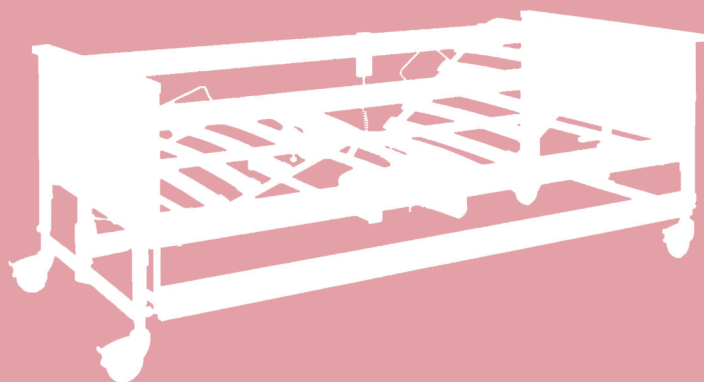



Slaugai

SLAUGOS LOVA
NURSING BED
APRŪPES GULTA

Economic II

Economic_II Economic_II_metal Economic_II_short



 <p>Max. kg</p>	 <p>Kg</p>	
185 kg	93 kg	40-80 cm

Slaugai

Modelis / Model / Modelis	Economic II	Economic II metal	Economic II short
Išoriniai matmenys / External dimensions / Ārējie izmēri	101x212 cm	101x212 cm	101x192 cm
Gulimo paviršiaus matmenys / Laying platform dimensions / Guļamvietas izmēri	90x200 cm	90x200 cm	90x180 cm
Nugaros atamos posvyrio kampas / Backrest angle / Atzveltnes leņķis	0-70°	0-70°	0-70°
Koju atamos posvyrio kampas / Legrest angle / Kāju atbalsta leņķis	0-35°	0-35°	0-35°
Ratukų skersmuo / Diameter of casters / Riteņu diametrs	100 mm	100 mm	100 mm
Aukštis reguluojamas elektra / Electric height adjustment / Elektriskā augstuma regulēšana	●	●	●
Nugaros atrama reguluojama elektra / Electric backrest adjustment / Elektriskā atzveltnes regulēšana	●	●	●
Koju lenkimo kampas reguluojamas elektra / Electric legrest angle adjustment / Kāju atbalstu elektriskā regulēšana	●	●	●
Pultelis su funkcijų užrakinimu / Handset with selective function locking / Pults ar selektīvo bloķēšanas funkciju	●	●	●
Metalinis gulimas paviršius / Metal laying platform / Metāla guļamvieta		●	●
Medinis gulimas paviršius / Wooden laying platform / Koka guļamvieta	●		
Mediniai nuleidžiami šoniniai turėklai / Lowered wooden side rails / Pazeminātas koka sānu sliekšes	●	●	●
Individualūs stabdžiai / Individuals brakes / Atsevišķas bremzes	●	●	●
Pasikēlīmo rankena / Lifting pole / Rokturis	●	●	●



Slaugai

KUŠETĖ
MEDICAL COACH
KUŠETE

SRS



 180 kg	 27 kg	 51 cm	 188 cm	 55 cm
---	--	--	---	--

Slaugai

SPINTELĖ PRIE LOVOS
BEDSIDE CABINET
SKAPĪTIS PIE GULTAS

UNO

Uno



80



30 kg



25 kg

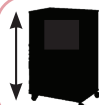

75 cm



45 cm



45 cm

Slaugai

SPINTELĖ PRIE LOVOS
BEDSIDE CABINET
SKAPĪTIS PIE GULTAS

HERMAN

Herman



20 kg



32 kg



88 cm



55 cm



45 cm

Slaugai

SPINTELĒ PRIE LOVOS
BEDSIDE CABINET
SKAPĪTIS PIE GULTAS

CHERUSKER

Cheruser



82



Max.
kg

26 kg



Kg

36 kg



87 cm



56 cm



51 cm

Slaugai

LIGONIO STALIUKAS VIRŠ LOVOS

OVERBED DINING TABLE

SLIMNIEKA GALDIŅŠ VIRS GULTAS NO DIVAM DAĻAM

01-8603



 20 kg	 10,4 kg	 82-117 cm	 67 cm	 39,5 cm
--	--	--	--	--

Slaugai

LIGONIO STALIUKAS VIRŠ LOVOS
PATIENT OVERBED TABLE
SLIMNIEKA GALDIŅŠ VIRS GULTAS

04-6700F



84



10 kg



7,2 kg



73-116 cm



61 cm







40 cm

Slaugai

LIGONIO STALIUKAS
OVERBED TABLE
SLIMNIEKA GALDIŅŠ

01-8604 01-8605



 <p>Max. kg</p>	 <p>Kg</p>			
15 kg	3,5 kg	40 cm	60 cm	01-8605 0°-35°

Slaugai

ATRAMA NUGARAI
BACK REST
MUGURAS BALSTS

01-7000

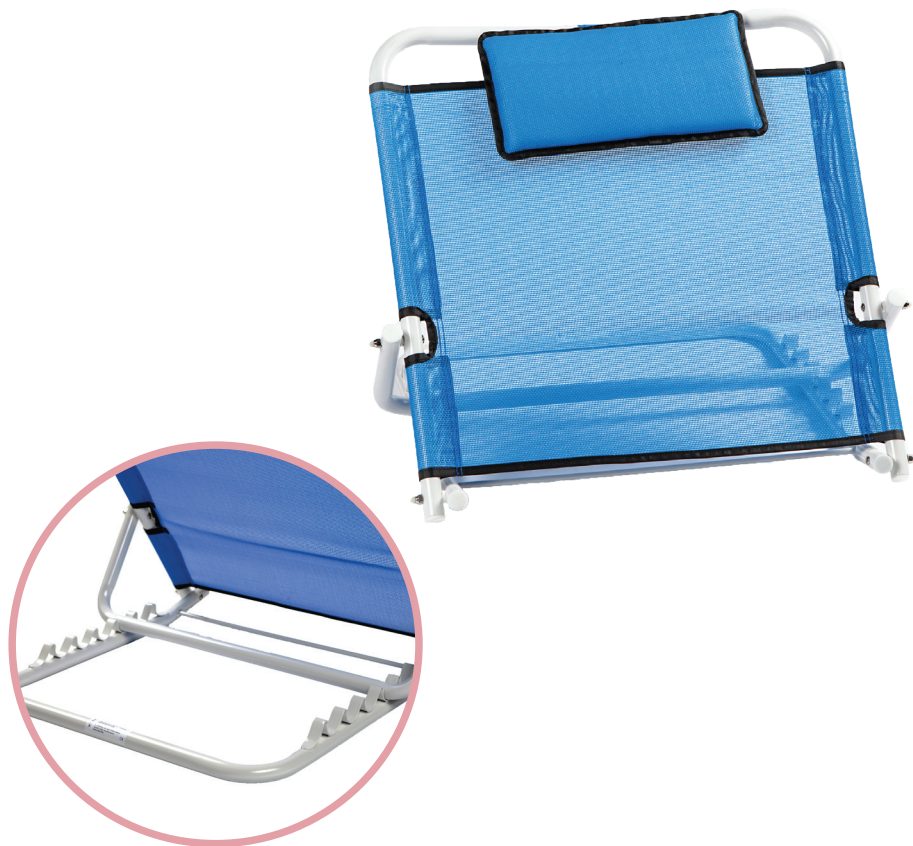

86



100 kg



2,6 kg



58,5 cm



58 cm





25°-80°

Slaugai

LAIPTELIAI PRIE LOVOS
STEPPER
GULTAS KĀPNĪTES

01-5710 01-5700



 <p>Max. kg</p>				
120 cm	22 kg	28,5 cm	26,5 cm	90 cm

Slaugai

MEDICININĖ SIENELĖ (ŠIRMA)
PRIVACY SCREEN
MEDICĪNISKAIS AIZSLIETNIS

01-8520 01-8521



Kodas
Code
Kods

01-8520
01-8521



6,2 kg
7,1 kg

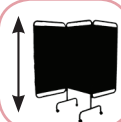

175 cm
175 cm

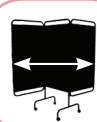

207 cm
216 cm

Slaugai

LAŠELINĒS STOVAS INFUSION STAND STATĪVS INFŪZIJĀM

01-5502

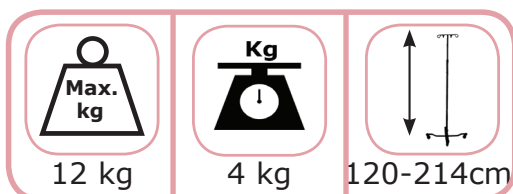

Slaugai

PERKĒLIMO NEŠTUVAI
LIFTING MAT
PĀRVIETOŠANAS LĪDZEKLIS

06-4703 06-4704



06-4703



06-4704

Kodas
Code
Kods

06-4703
06-4704



150 kg
180 kg



53 cm
53 cm



110 cm
150 cm

Slaugai

ČIUŽINYS PRAGULŲ PROFILAKTIKAI SU KOMPRESORIUMI AIR ANTI BED-SORE MATTRESS MATRACIS IZGULĖJUMU PROFILAKSEI AR KOMPRESORU

02-M7



110 kg



3,9 kg

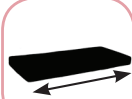

200 cm



90 cm



6 cm

Slaugai

ČIUŽINYS PRAGULŲ PROFILAKTIKAI SU KOMPRESORIUMI AIR ANTI BED-SORE MATTRESS MATRACIS IZGULĖJUMU PROFILAKSEI AR KOMPRESORU

02-M8



92



150 kg



5,5 kg

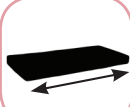

196 cm

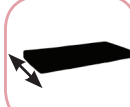

86 cm



12,7 cm





Slaugai

POROLONINIS ČIUŽINYS PRAGULŲ PROFILAKTIKAI **ANTI BED-SORE FOAM MATTRESS** **POROLONA MATRACIS IZGULĖJUMU PROFILAKSEI**

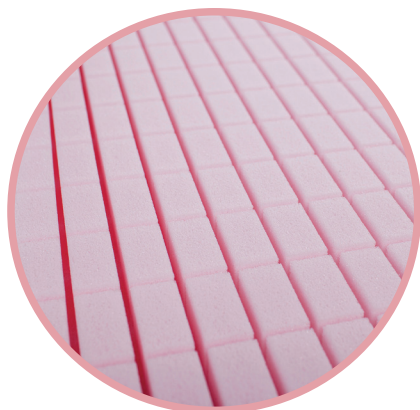
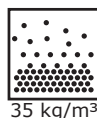
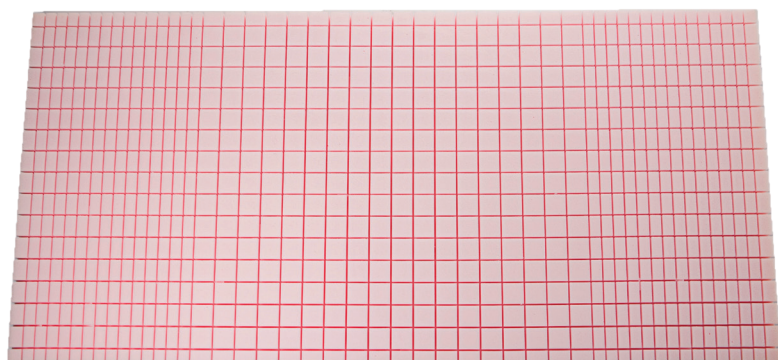
KUBA

KUBA



 110 kg	 7 kg	 200 cm	 90 cm	 11 cm
---	---	---	--	--

Slaugai

POROLONINIS ČIUŽINYS PRAGULŲ PROFILAKTIKAI
ANTI BED-SORE FOAM MATTRESS
POROLONA MATRACIS IZGULĖJUMU PROFILAKSEI

KUBAUT

KUBAUT



50 kg/m³



94



140 kg



11 kg

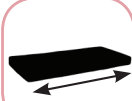

200 cm



90 cm



14 cm

Slaugai

POROLONINIS ČIUŽINYS PRAGULŲ PROFILAKTIKAI **ANTI BED-SORE FOAM MATTRESS** **POROLONA MATRACIS IZGULĖJUMU PROFILAKSEI**

VISKO-2

VISKO-2

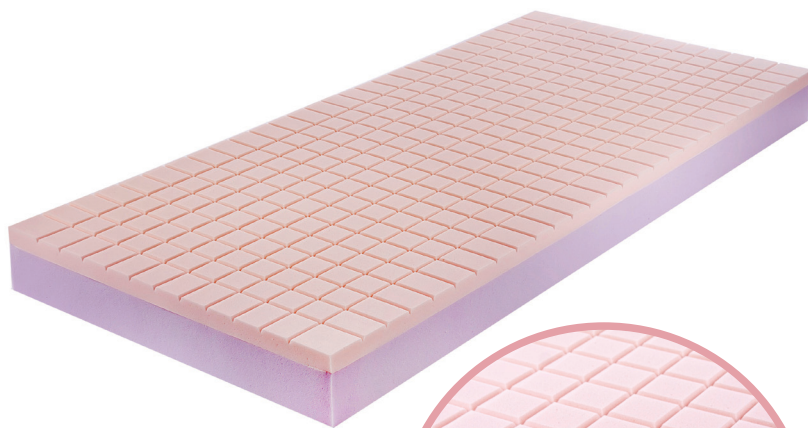

60/42
kg/m³



200 kg



13 kg



200 cm



90 cm



15 cm

Slaugai

POROLONINIS ČIUŽINYS PRAGULŲ PROFILAKTIKAI
ANTI BED-SORE FOAM MATTRESS
POROLONA MATRACIS IZGULĖJUMU PROFILAKSEI

VISKO-3

VISKO-3

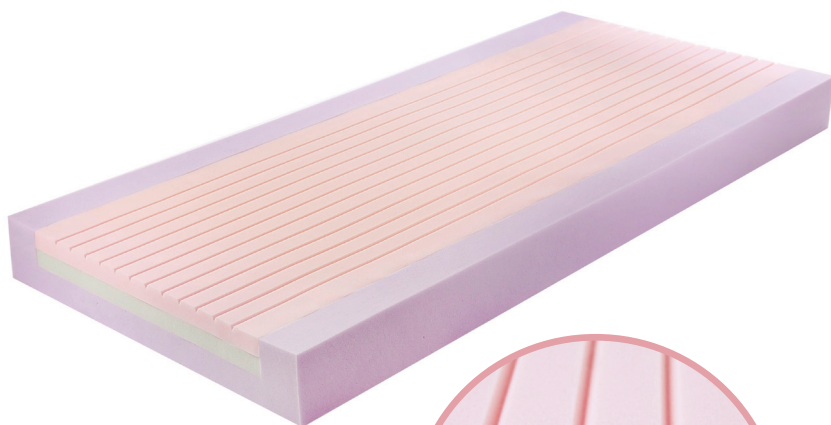

60/37/42
kg/m³



96



240 kg



14 kg

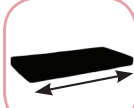

200 cm



90 cm



15 cm





Slaugai

MEDICININIS ČIUŽINYS
MEDICAL MATTRESS
POROLONA MATRACIS

MEDAS

MEDAS

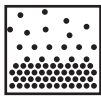

Kodas Code Kods				
MEDAS/2009010/25	200x90x10 cm	120 kg	25 kg/m ³	4,5 kg
MEDAS/2009010/35	200x90x10 cm	120 kg	35 kg/m ³	6,3 kg
MEDAS/2009012/25	200x90x12 cm	120 kg	25 kg/m ³	5,4 kg
MEDAS/2009012/35	200x90x12 cm	120 kg	35 kg/m ³	7,6 kg

Slaugai

**SKYSČIAMIS NEPRALAUDUS KVĖPUOJANTIS UŽVALKALAS
 ČIUŽINIUI**
 WATERPROOF MATTRESS PROTECTIVE COVER
 AIZSARDZĪBAS ŪDENSNECAURLAIDĪGS PĀRVALKS MATRACIM

HL-7300





Kodas Code Kods		Kg 
HL-7300/2009010	200x90x10 cm	0,5 kg
HL-7300/2009011	200x90x11 cm	0,5 kg
HL-7300/2009012	200x90x12 cm	0,5 kg
HL-7300/2009014	200x90x14 cm	0,5 kg
HL-7300/2009015	200x90x15 cm	0,5 kg

Slaugai

SKYŠČIAMŠ NEPRALAIĐI PAKLOĐŠ SU GUMA
WATERPROOF FITTED SHEET
ŪDENSNECAURLAIĐĪGS PĀRVALKS

HL-7500

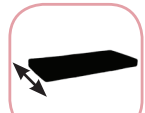
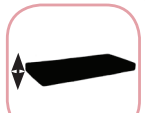

 0,4 kg	 200 cm	 90 cm	 14 cm
---	---	--	--

Slaugai

SKYSČIAMŠ NEPRALAIĐI FROTĒ PAKLOĐĒ SU GUMA
WATERPROOF FACECLOTH FITTED SHEET
PĀRKLĀJUMŠ

HL-7100



Slaugai

ABSORBUOJANTIS DAUGKARTINIS PAKLOTAS

ABSORBING PAD, REUSABLE

ADSORBĒJOŠS PAKLĀJIŅŠ, MULTIFUNKCIONĀLS

HL-7200

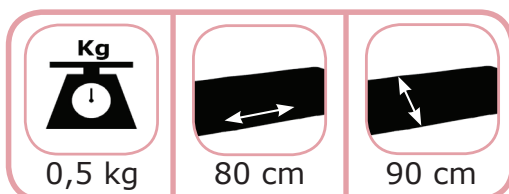

Slaugai

ABSORBUOJANTIS DAUGKARTINIS PAKLOTAS SU RANKENOMIS

ABSORBING PAD WITH HANDLES, REUSABLE
ABSORBĒJOŠS PAKLĀJIŅŠ AR ROKTURIEM, MULTIFUNKCIONĀLS

HL-7200_RANK



Slaugai

SKYSČIAMŠ NEPRALAIĐI PUSPAKLODĖ
WATERPROOF HALF SHEET
ŪDENSNECAURLAIĐĪGS PALAGS

HL-7400

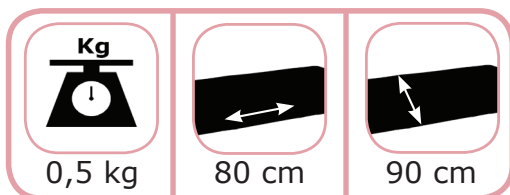
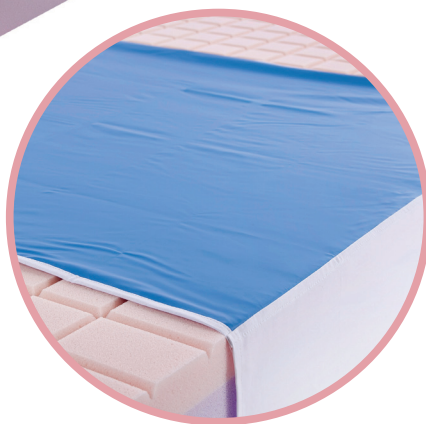
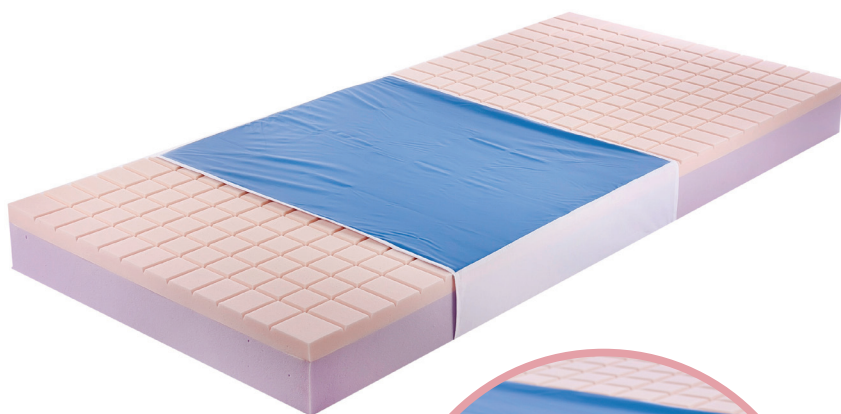

Slaugai

POZICIONAVIMO PAGALVĖLĖ - TRIKAMPIS
SUPPORT WEDGE
ATBALSTA KĪLIS

HL-1000

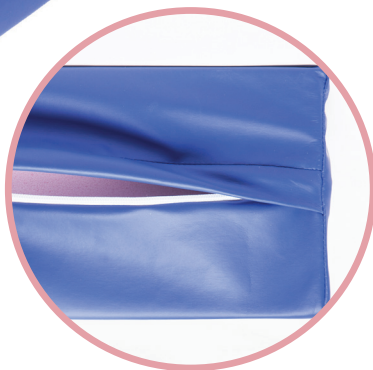
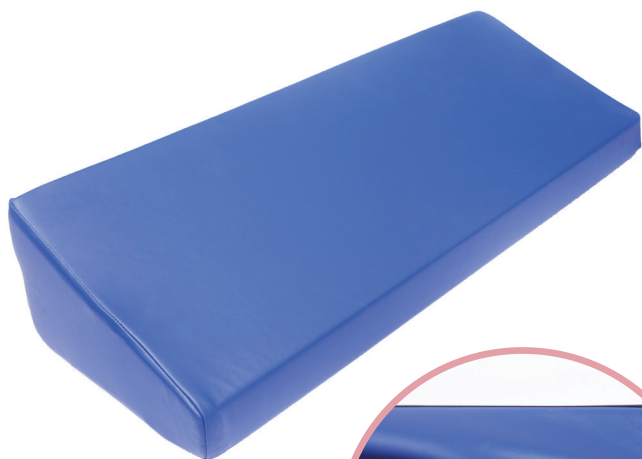

104



0,8 kg

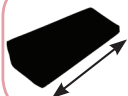

70 cm

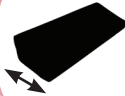

25 cm



15x5 cm

Slaugai

POZICIONAVIMO VOLAS
POSITIONING ROLL
POZICIONĖŠANAS RULLIS

HL-2100 HL-2200

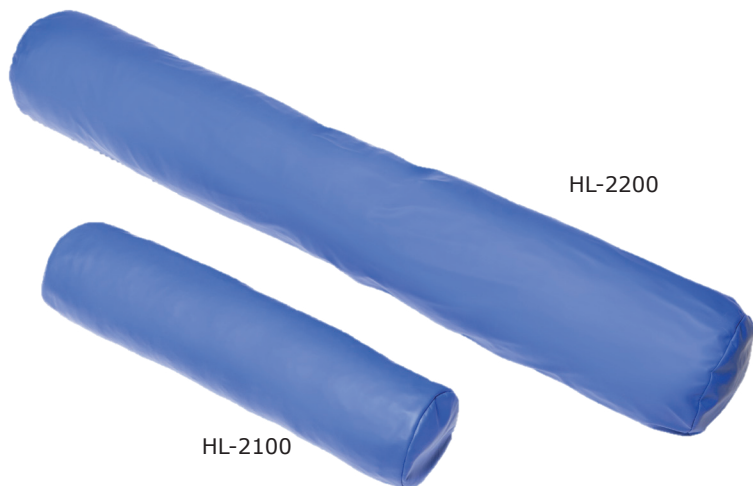

HL-2100

HL-2200

Kodas
Code
Kods

HL-2100
HL-2200



0,5 kg
1,5 kg



60 cm
125 cm



15 cm
20 cm

Slaugai

POZICIONAVIMO PAGALVĖ
POSITIONING PILLOW
POZICIONĖŠANAS SPILVENS

HL-3100, HL-3200

HL-3200



HL-3100

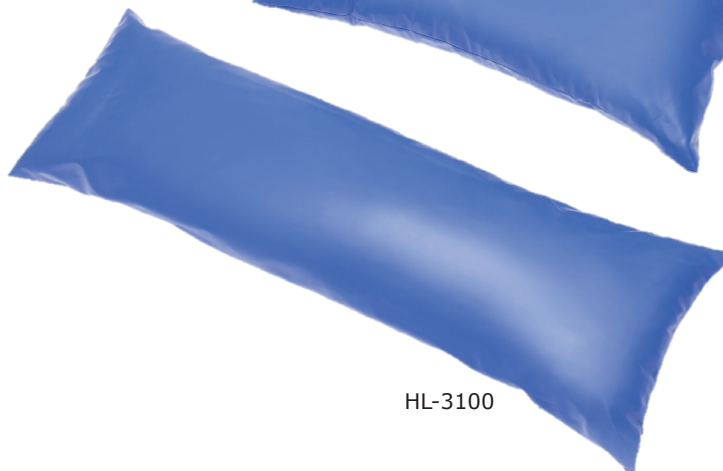

Kodas
Code
Kods

HL-3100
HL-3200



0,5 kg
1,1 kg



80 cm
60 cm

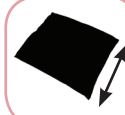

25 cm
50 cm

Slaugai

DAUGIAFUNKCĒ PAGALVĒ MULTI PILLOW DAUDZFUNKCIONĀLS SPILVENS

HL-3300



Slaugai

POROLONINIS POZICIONAVIMO VOLAS
FOAM POSITIONING ROLL
POZICIONĖŠANAS RULLIS

HL-4100, HL-4200

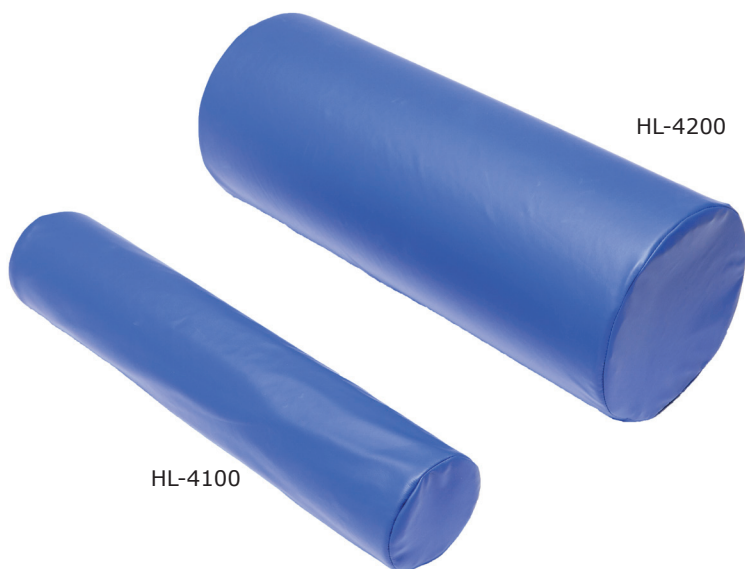

Kodas
Code
Kods

HL-4100
HL-4200



0,2 kg
0,7 kg



50 cm
52 cm



10 cm
20 cm

Slaugai

POZICIONAVIMO APYKAKLĖ - PAGALVĖ NECK PILLOW SPILVENS KAKLAM

HL-5000



Slaugai

KULNŲ APSAUGA HEEL PROTECTION PAPĒŽA AIZSARDZĪBA

HL-6000



110



0,4 kg



12 cm

Slaugai

ORTOPEDINĖ PAGALVĖ ORTHOPEDIC PILLOW ORTOPĒDISKAIS SPILVENS

MAJA

MAJA

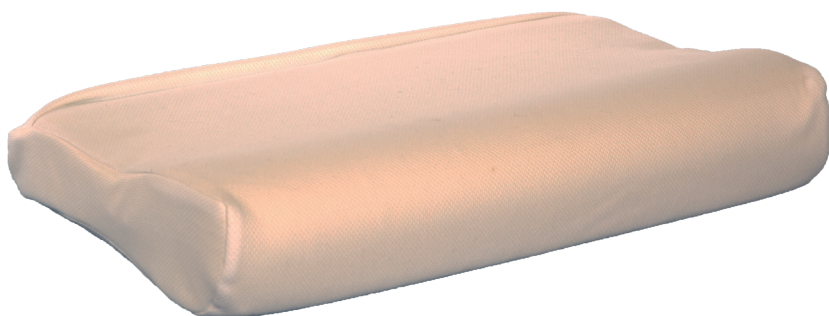

1,1 kg



60 cm



34 cm



10/7 cm

Slaugai

ORTOPEDINĖ PAGALVĖ
ORTHOPEDIC PILLOW
ORTOPĒDISKAIS SPILVENS

MAJA PLUS

MAJA_PLUS

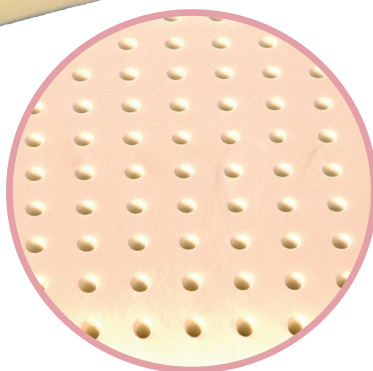
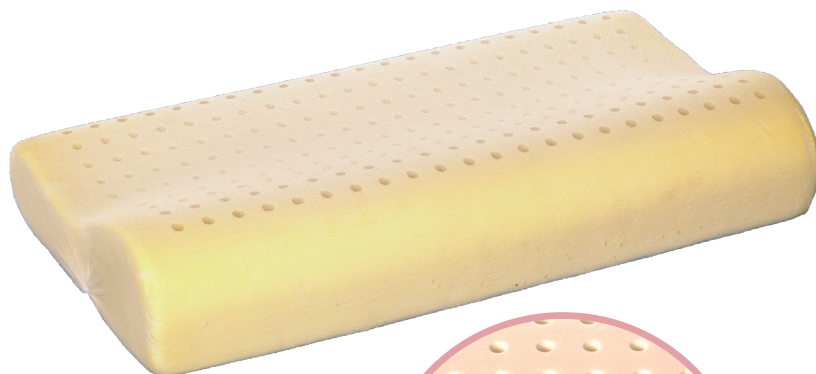

112



1,1 kg



60 cm



34 cm



10/7 cm

Slaugai

KLASIKINĖ PAGALVĖ CLASSIC PILLOW KLASISKAIS SPILVENS

LUNA

LUNA



1,5 kg



66 cm



42 cm



11 cm

Slaugai

KLASIKINĖ PAGALVĖ
CLASSIC PILLOW
KLASISKAIS SPILVENS

LUNA PLUS

LUNA PLUS MINI

LUNA_PLUS

LUNA_PLUS_MINI

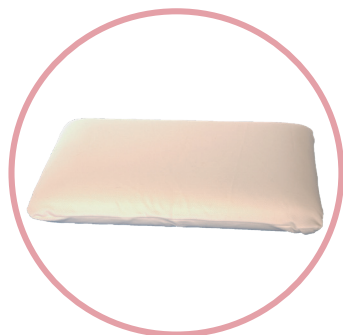

Kodas
Code
Kods

LUNA PLUS

LUNA PLUS MINI

Kg



1,5 kg

0,9 kg



66 cm

42 cm



42 cm

33 cm



11 cm

11 cm



UAB Kasko Group | Kid-Man™
A. Vivulskio str. 12D, 03221
Vilnius, Lithuania
Tel. 00 370 5 216 74 25
www.kid-man.eu

