



ALLMOBILITY TRADING S.r.l.

"BUFFALO 150" BOARD

USER TRANSFER SUPPORT



Product complying with the requirements of Directive 2007/47/EC.

INSTRUCTIONS FOR USE
Version 001-16

INDEX

1. PRODUCT DESCRIPTION.....	3
2. TECHNICAL DATA	3
3. GENERAL INFORMATION	4
4. INSTRUCTIONS FOR USE	5
5. DISPOSAL	7
6. WARRANTY - ASSISTANCE	7

1. PRODUCT DESCRIPTION

The product described in these instructions is an easy-glide synthetic fibre board for user transfer.

It is designed to be easily transportable, in fact it is only 4 mm thick and has a handle hole.

The *BUFFALO 150* board is brightly coloured and has a double notch for greater stability and to ensure maximum safety during transfer.

The composite fibre ensures high resistance and avoids harmful chipping of the surface which occurs over time with other materials.

The *BUFFALO 150* board is an aid characterised by flexibility and versatility of use.

It can be easily used for small transfers in any indoor environment, for example in the bedroom, living room, kitchen or bathroom; or outdoors, for example in a car, on a bench or chair, for moving from or to the wheelchair.

Some illustrations:

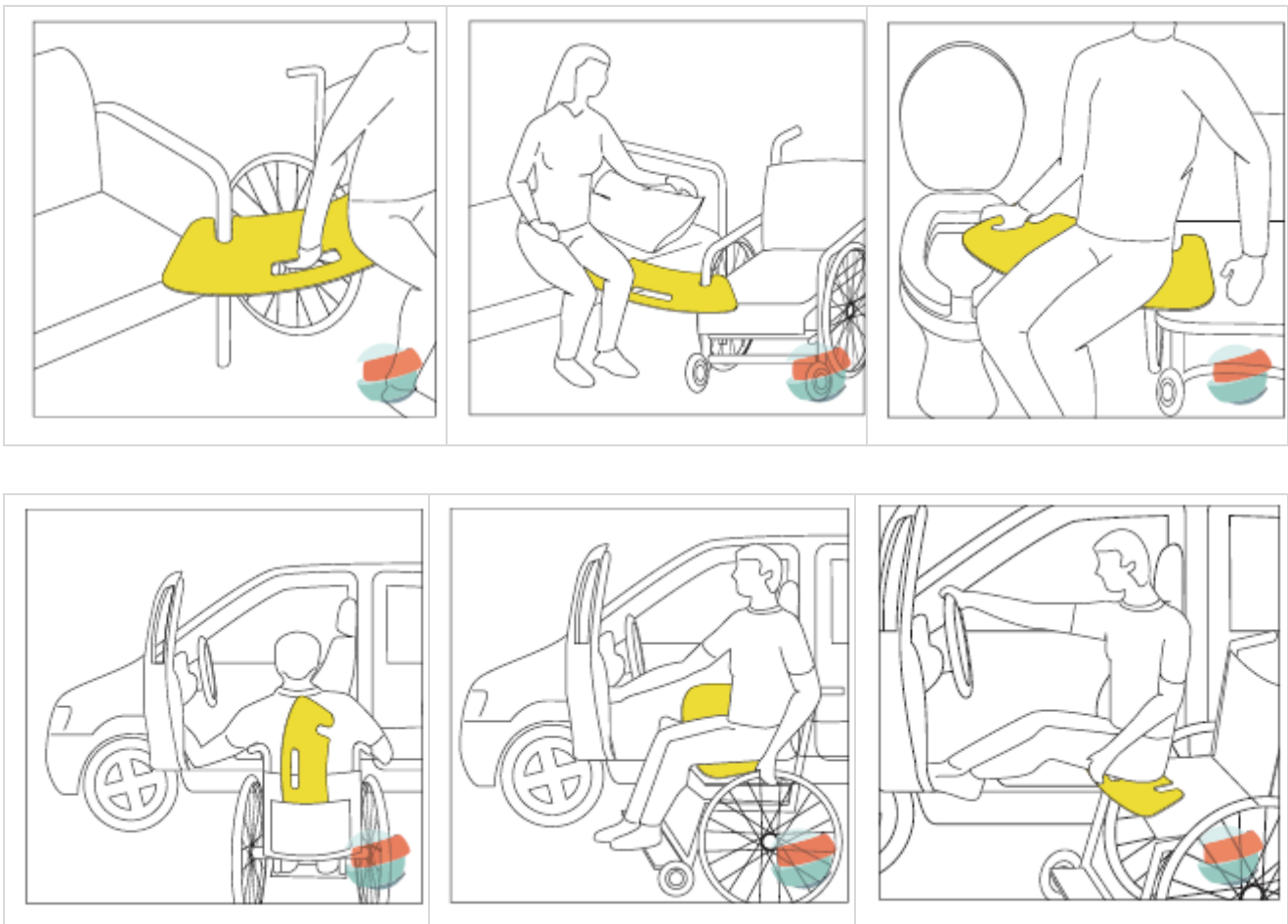

2. TECHNICAL DATA

"BUFFALO 150" BOARD

DIMENSIONS	WEIGHT (Kg)	BEARING CAPACITY (Kg)
<p>  77 cm  32,5 cm  0,4 cm LENGTH = 77cm WIDTH = 32.5cm THICKNESS = 0.4cm </p>	<p>1.23</p>	<p>150</p> <p><i>distributed over a surface of 40 cm, with resting weight of 25 kg on the sides</i></p>

STORAGE TEMPERATURE

ADMISSIBLE TEMPERATURE RANGE:

MINIMUM = -5 °C

MAXIMUM = +40 °C

3. GENERAL INFORMATION

The board has been designed and made to be safe in the use for which it is intended, as long as it is used and stored as indicated in these instructions.

Given below are the main instructions and correct storage by the user to as to reduce situations of risk.



= PAY ATTENTION!



= FORBIDDEN ACTION



The board is a medical aid for facilitating the transfer of a disabled user from a wheelchair to another seat.

DO NOT USE THE BOARD FOR ANY PURPOSE OTHER THAN THE ONE DESCRIBED IN CHAPTER 2.



DO NOT USE THE BOARD IF IT SHOWS ANY SIGN OF DAMAGE, DEFORMATION, CRACKS, THINNING, BREAKAGES.



DO NOT USE THE BOARD TO TRANSFER WEIGHTS/PERSONS HEAVIER THAN THE MAXIMUM ALLOWED BEARING CAPACITY (150 Kg).



**DO NOT USE CORROSIVE PRODUCTS TO CLEAN THE BOARD.
ALL IT NEEDS IS A DAMP CLOTH, SURGICAL SPIRIT OR ORDINARY SOAP.**



FOLLOW THE INSTRUCTIONS FOR USE PROVIDED ON THE BOARD AND IN CHAPTER 4.



MAKE SURE THAT THE DISTANCE TO THE POINT OF ARRIVAL IS IDEAL FOR A CORRECT AND STEADY POSITIONING OF THE BOARD.



WHEN POSSIBLE, AS WELL AS ONTO THE ARM OF THE WHEELCHAIR, HOOK THE BOARD ALSO ONTO A SUPPORT ON THE POINT OF ARRIVAL.





IF THE INSTRUCTIONS ON THE LABEL APPLIED ON THE BOARD ARE SO WORN THAT THEY ARE NO LONGER LEGIBLE, ASK THE MANUFACTURER FOR A NEW COPY.



4. INSTRUCTIONS FOR USE

The *BUFFALO 150* board is a support for transferring the user from the wheelchair to another position, for example to the bed, couch, car, etc.

It does not have any packaging, so it is bought, used, kept and carried just as it is.

Shown below are some of the most frequent uses and how to perform them, as shown also on the label applied on the accessory.

			<p><u>TRANSFER TO THE CAR</u></p> <p>Get as close as possible to the seat, secure the board to the arm of the wheelchair and ensure that it is resting firmly on the seat.</p>
---	---	---	---

			<p><u>TRANSFER TO THE BED</u></p> <p>Get as close as possible to the bed, secure the board to the arm of the wheelchair and ensure that it is resting firmly on the mattress.</p>
--	--	--	--

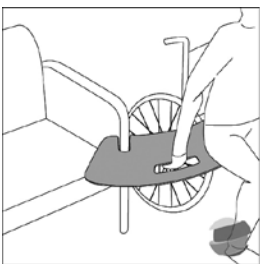
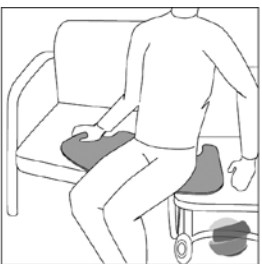
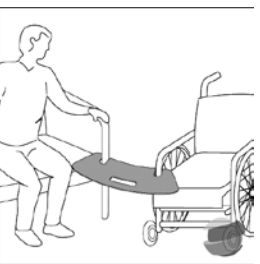
			<p><u>TRANSFER TO A CHAIR/COUCH</u></p> <p>Get as close as possible to the chair/couch, secure the board to the arm of the wheelchair and to the armrest of the chair/couch (if possible) and ensure that it is resting firmly on the seat.</p>
---	---	---	--

			<p><u>TRANSFER TO THE TOILET</u></p> <p>Get as close as possible to the toilet, secure the board to the arm of the wheelchair and ensure that it is resting firmly on the seat.</p>
---	---	---	--

ALWAYS FOLLOW THE INSTRUCTIONS IN CHAPTER 3.

5. DISPOSAL

When the board is no longer to be used, dispose of it correctly without dumping it in the environment.
Follow the rules for disposal in force in the place of use of the accessory (ask the local authorised disposal companies).

6. WARRANTY - ASSISTANCE

Listed below are the general terms of the warranty applied by the Manufacturer **ALLMOBILITY TRADING S.r.l.** .

The warranty applies to all manufacturing and material defects, duly confirmed at the Company's discretion.

The Warranty does not cover damage caused by:

- *Normal wear and tear*
- *Deterioration of parts with purely aesthetic functions*
- *Repairs or modifications carried out by unauthorised persons or centres*
- *Use of the product not complying with the warnings given in this manual*
- *Damage caused by unsuitability of the environment in which the product is used and by phenomena not depending on its normal operation.*

In case of sale the warranty has a duration of 1 (one) year.

For any problem or to request information, contact the Manufacturer at the addresses on the first page.

7. VERSIONE BUFFALO GRIP 150

The BUFFALO GRIP 150 version (code All03 grip) **features two high-grip areas on the bottom.**

This stabilises the end surfaces of the board when they are in contact with soft parts, such as the padding or fabric of a chair, armchair, car or wheelchair cushion.

This allows some types of users to make the transfer according to their own preference.

The **material** is a “cushion grip” H3408 s, made of 51% polyurethane and 49% polyester, with an adhesive acrylic base, 1 mm thick.

The **shape and dimensions** (in mm) are those shown in the figure.

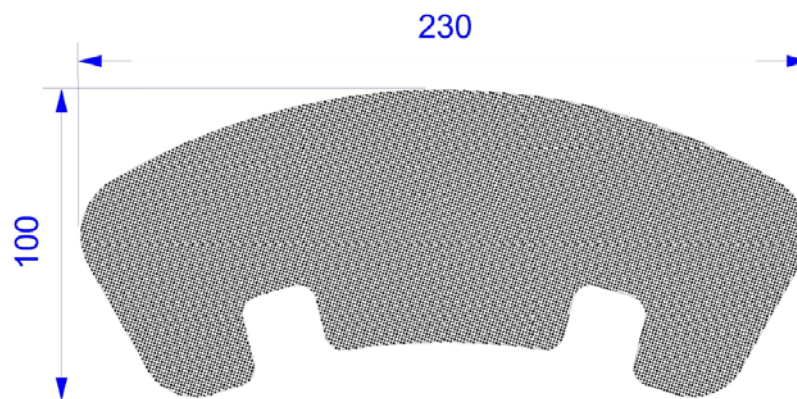

Do not use the board with the grip at the top (in contact with the body) during transfers.



ALLMOBILITY TRADING S.r.l.

"BUFFALO 150" DESKA
POMOČ PRI PRENOSU UPORABNIKA



Izdelek v skladu z zahtevami Direktive 2007/47/ES.

NAVODILA ZA UPORABO
Različica 001-16

KAZALO

1. OPIS IZDELKA	3
2. TEHNIČNI PODATKI	3
3. SPLOŠNE INFORMACIJE	4
4. NAVODILA ZA UPORABO.....	5
5. ODSTRANITEV / RECIKLAŽA	7
6. GARANCIJA - SERVIS.....	7

1. OPIS IZDELKA

Izdelek, opisan v teh navodilih, je drsna deska iz sintetičnih vlaken za prenos uporabnika.

Zasnovana je za enostaven transport, saj je debela le 4 mm in ima odprtino za ročaj.

Deska BUFFALO 150 je živo obarvana in ima dvojni zarez za večjo stabilnost ter za zagotavljanje največje varnosti med prenosom.

Kompozitna vlakna zagotavljajo visoko odpornost in preprečujejo škodljive odkruške površine, ki se sčasoma pojavljajo pri drugih materialih.

Deska BUFFALO 150 je pripomoček, ki se odlikuje po prilagodljivosti in vsestranski uporabi.

Zlahka se uporablja za kratke premike v katerem koli notranjem prostoru, na primer v spalnici, dnevni sobi, kuhinji ali kopalnici; ali na prostem, na primer v avtomobilu, na klopi ali stolu, za prehode iz ali v invalidski voziček.

Nekaj ilustracij:

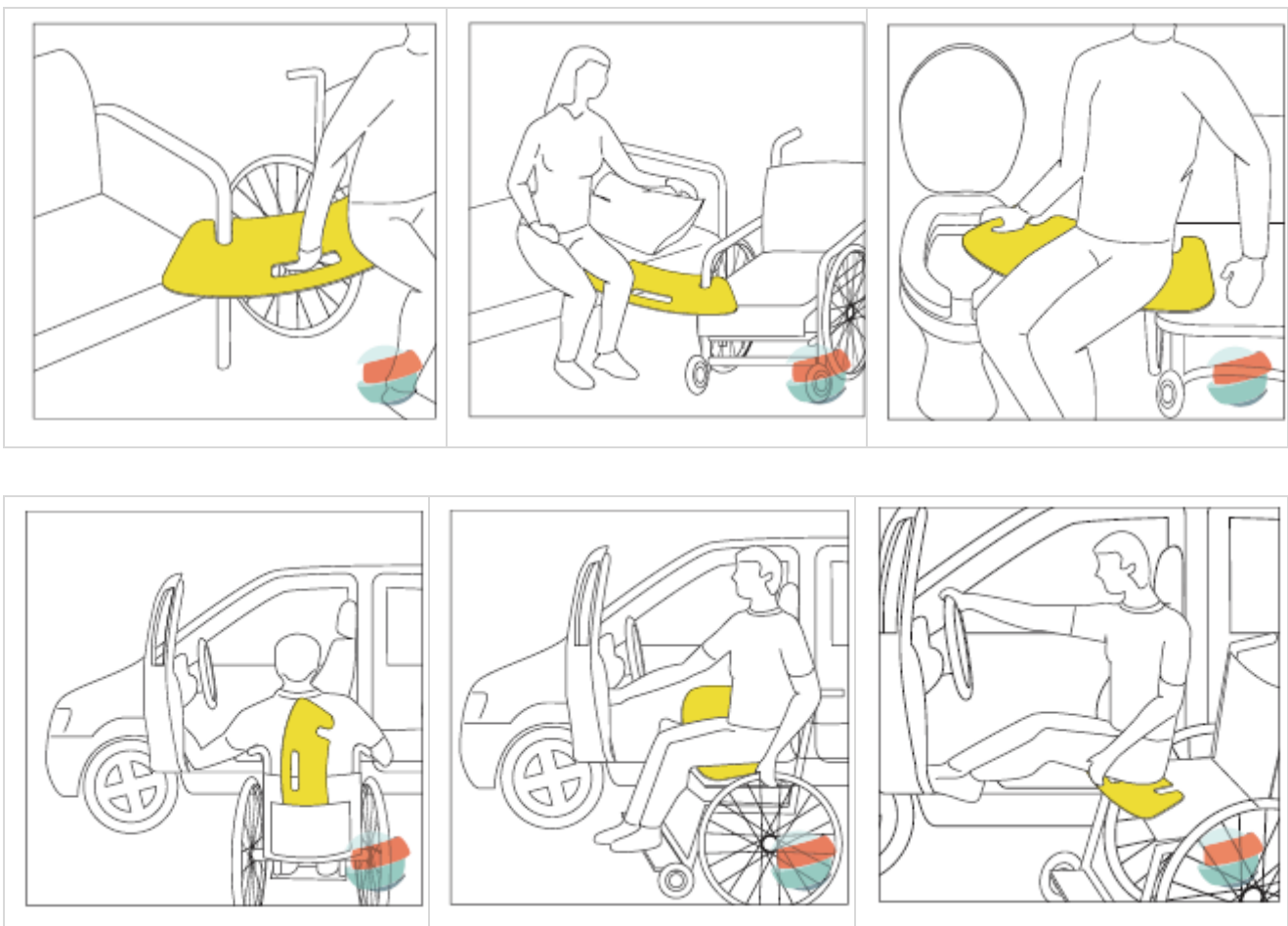

2. TEHNIČNI PODATKI

"BUFFALO 150" DESKA

DIMENZIJE	TEŽA (Kg)	NOSILNOST (Kg)
<p>↔ 77 cm</p> <p>↗ 32,5 cm</p> <p>↕ 0,4 cm</p> <p>DOLŽINA = 77cm</p> <p>ŠIRINA = 32.5cm</p> <p>DEBELINA = 0.4cm</p>	1.23	150
		<p><i>Obremenitev porazdeljena na površini 40 cm, z nosilnostjo 25 kg ob straneh.</i></p>

TEMPERATURA SHRANJEVANJA

DOPUSTNI TEMPERATURNI RAZPON:

MINIMALNO = -5 °C

MAKSIMALNO = +40 °C

3. SPLOŠNE INFORMACIJE

Deska je zasnovana in izdelana tako, da je varna za predvideno uporabo, če se uporablja in shranjuje v skladu z navodili.

Spodaj so navedena glavna navodila in pravilno shranjevanje s strani uporabnika, da se zmanjšajo tveganja.



= POZOR!



= PREPOVEDANO



Deska je medicinski pripomoček za prenos uporabnika z invalidskega vozička na drug sedež.

NE UPORABLJAJTE DESKE ZA KAKRŠEN KOLI DRUG NAMEN, KOT JE OPISANO V POGlavJU 2.



NE UPORABLJAJTE DESKE, ČE KAŽE KAKRŠNE KOLI ZNAKE POŠKODB, DEFORMACIJ, RAZPOK, TANJŠANJA, LOMOV.



NE UPORABLJAJTE DESKE ZA PRENOS TEŽ / OSEB, KI SO TEŽJE OD NAJVEČJE DOVOLJENE NOSILNOSTI (150 Kg).



NE UPORABLJAJTE KOROZIVNIH IZDELKOV ZA ČIŠČENJE DESKE. VSE, KAR JE POTREBNO, JE VLAŽNA KRPA, ALKOHOL ALI OBIČAJNO MILO.



SLEDUJTE NAVODILOM ZA UPORABO, KI SO NAVEDENA NA DESKI IN V POGlavJU 4.



PREPRIČAJTE SE, DA JE RAZDALJA DO CILJNE TOČKE PRIMERNA ZA PRAVILNO IN STABILNO NAMESTITEV DESKE.



KADAR JE MOGOČE, ZATKNITE DESKO NE SAMO NA NASLON INVALIDSKEGA VOZIČKA, AMPAK TUDI NA OPORO V CILJNI TOČKI.



ČE SO NAVODILA NA NALEPKI, PRILEPLJENI NA DESKO, TOLIKO OBRABLJENA, DA NISO VEČ BERLJIVA, ZAHTEVAJTE NOV IZVOD PRI PROIZVAJALCU.

4. NAVODILA ZA UPORABO

Deska BUFFALO 150 je pripomoček za prenos uporabnika z invalidskega vozička na drugo mesto (postelja, kavč, avto ipd.).

Deska nima embalaže, zato se kupuje, uporablja, shranjuje in prenaša takšna, kot je.

Spodaj so prikazane nekatere najpogostejše uporabe in način njihove izvedbe, kot je prikazano tudi na nalepki, pritrjeni na pripomočku.

			<p><u>PRENOS V AVTO</u></p> <p>Približajte se čim bližje sedežu, pritrдите desko na naslon invalidskega vozička in zagotovite, da trdno leži na sedežu.</p>
			<p><u>PRENOS NA POSTELJO</u></p> <p>Približajte se čim bližje postelji, pritrдите desko na naslon invalidskega vozička in zagotovite, da trdno leži na vzmetnici.</p>
			<p><u>PRENOS NA STOL/KAVČ</u></p> <p>Približajte se čim bližje stolu/kavču, pritrдите desko na naslon invalidskega vozička in na naslonjalo stola/kavča (če je mogoče) in zagotovite, da trdno leži na sedežu.</p>
			<p><u>PRENOS NA STRANIŠČE</u></p> <p>Približajte se čim bližje stranišču, pritrдите desko na naslon invalidskega vozička in zagotovite, da trdno leži na školjki.</p>

VEDNO UPOŠTEVAJTE NAVODILA IZ POGlavJA 3.

5. ODSTRANITEV / RECIKLAŽA

Ko deska ni več uporabna, jo odstranite pravilno in ne odvrzite v okolje.

Sledite pravilom o odstranitvi, ki veljajo na kraju uporabe pripomočka (vprašajte lokalne pooblaščenec odstranjevalne družbe).

6. GARANCIJA - SERVIS

Garancija velja za vse proizvodne in materialne napake, ki jih potrdi proizvajalec **ALLMOBILITY TRADING S.r.l.** .

Garancija velja za vse proizvodne in materialne napake, ki jih po presoji podjetja potrdi proizvajalec.

Garancija ne velja v primerih:

- Običajne obrabe
- Estetskih poškodb brez vpliva na delovanje
- Popravlil ali sprememb s strani nepooblaščenih oseb
- Nepravilne uporabe v nasprotju z opozorili
- Poškodbe, povzročene zaradi neprimernosti okolja, v katerem se izdelek uporablja, in zaradi pojavov, ki niso

V primeru prodaje garancija traja 1 (eno) leto.

Za kakršne koli težave ali zahteve po informacijah se obrnite na proizvajalca na naslovih na prvi strani.

7. VERZIJA BUFFALO GRIP 150

Različica BUFFALO GRIP 150 (koda All03 grip) ima na spodnji strani dve območji z visokim oprijemom.

To stabilizira končne površine deske, ko so v stiku z mehкими deli, kot so oblazinjenje ali tkanina stola, fotelja, avtomobila ali blazine invalidskega vozička.

To omogoča nekaterim uporabnikom, da opravijo prenos v skladu s svojo lastno izbiro.

Material je "cushion grip" H3408 s, sestavljen iz 51 % poliuretana in 49 % poliestra, z akrilno lepilno podlago, debeline 1 mm.

Oblika in dimenzije (v mm) so prikazane na sliki.

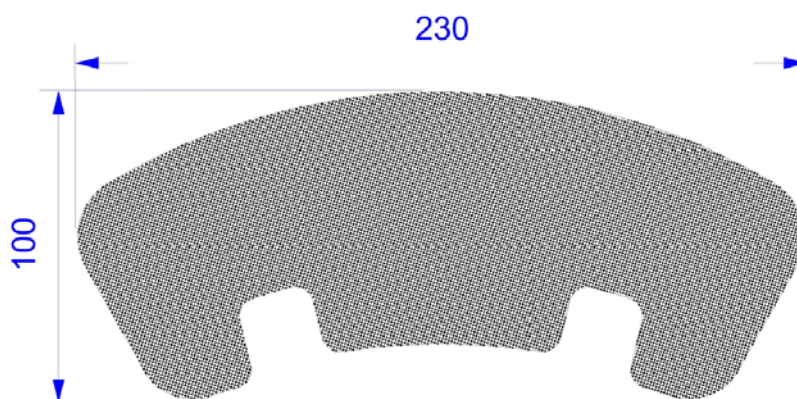

Ne uporabljajte deske z oprijemom na zgornji strani (v stiku s telesom) med prenosom.